

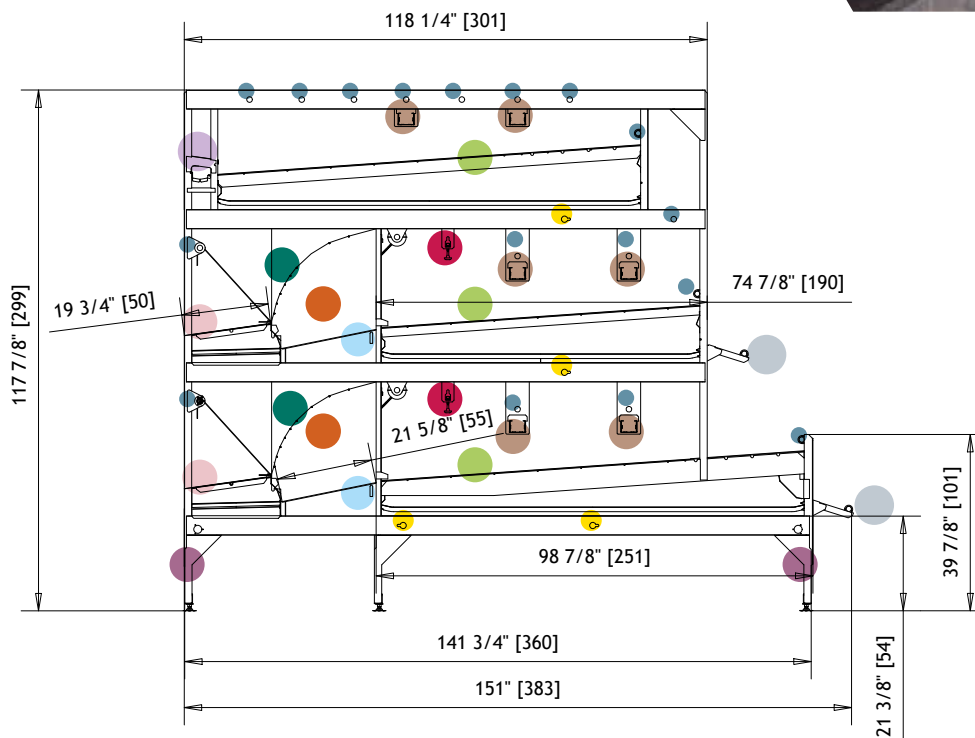











AS LOGGIA

Aviary System for Layers



3 PIANI
3 TIERS



- | | | | |
|---|---|---|--|
|  | Astroturf removibile e autopulente
Removable and self-cleaning astroturf |  | Sportello automatico/manuale
Automatic/manual door |
|  | Protezione nastro uova per maggior area utile
Protection cover over egg belt providing extra area |  | Apertura per ispezione nido centralizzata
Centralized opening for nest inspection |
|  | Mangiatoie dotate di profilo antispreco
Feed trough with anti-waste profile |  | Linea di abbeveraggio
Drinking line |
|  | Trespole mobile (può essere usato per l'ispezione)
Movable perch (can be used for inspection) |  | Bandina/Trespole protezione uova in acciaio inox
Egg protection profile/perch in stainless steel |
|  | Nido con apertura automatica
Nest with automatic movement for ejection |  | Trespole
Perch |
|  | Piani inclinati per consentire alle uova esterne di convergere nel nido
Sloping floors to allow non nest eggs to roll into the nest |  | Illuminazione a Led
Led lighting |

VANTAGGI

- > Estrema compattezza per massimizzare il numero di animali presenti nell'impianto con ottimale distribuzione di componenti
- > Sistema aperto studiato per avere un ottimale movimento degli animali ed elevare il livello di welfare
- > Facilità di ispezione per tutto il sistema grazie all'apertura posteriore del nido con movimentazione centralizzata
- > Nido con tappeto astroturf forato e pavimento mobile, per maggior pulizia
- > Copertura nastro uova con superficie utilizzabile
- > Larghezza del nastro delle uova aumentata per migliorare il trasporto delle uova
- > Progettato per agevolare l'operatore
- > Materiali ad elevata resistenza e qualità

BENEFITS

- > Extremely compact design to maximize the number of birds in the barn with optimal distribution of accessories
- > Open system designed to have an optimal movement of birds to elevate the level of welfare
- > Easy inspection for the whole system thanks to the rear opening of the nest with centralized system
- > Nest with perforated astroturf & moving floor, for cleaner eggs
- > Egg belt cover countable as usable surface
- > Increased egg belt width to improve egg transport and reduce damage
- > Designed with the operator in mind
- > Materials with high quality corrosion resistance

AS LOGGIA

Aviary System for Layers

2 PIANI
2 TIERS

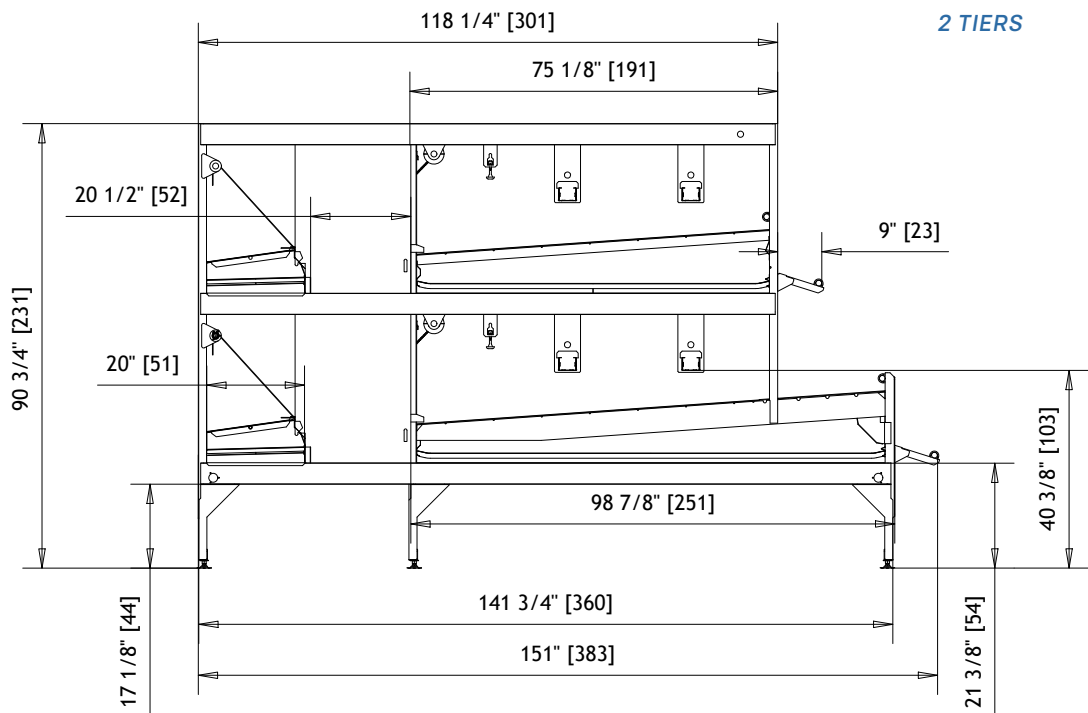

Scansiona il codice QR
per scoprire di più.

Scan the QR code to
find more.

Contatta il tuo referente Tecno o visita il nostro sito
per maggiori informazioni.

Contact your Tecno representative or visit our
website for more information.

poultryequipment.com